

INSTALLATION INSTRUCTIONS

CAT 950B/E MODEL WHEEL LOADERS

HAMMOND AIR CONDITIONING LTD
INGERSOLL, ONT.
1-800-267-2665
1-888-267-3745 (FAX)

CAT 950B E INSTRUCTIONS

EVAPORATOR COIL:

The evaporator coil goes alongside the heater core in the heater blower assembly behind the operator's position.

1. Remove the cover, filters and blowers from above the heater unit behind the seat. Remove the filter locking mechanism and the cover plate.
2. Loosen the lower nut on the left side of the heater and remove the upper nut on the same side. Remove the fasteners on the other end of the coil.
3. Ensure the drain tubes are clear.
4. Insert the evaporator coil and fasten in place using the original hardware.
5. The hoses attached to the evaporator coil are run out the existing knock outs at the lower corner of the heater/evaporator box. The 5/16" hose goes into the lower knock out and uses the large flat washers provided.
6. Do not reassemble the blowers and filter assemblies until the system has been tested for leaks.



Evaporator in place for 950E, F with hoses.

COMPRESSOR:

The compressor mounts on the lower left hand side of the engine on the engine mount and drives off of the open pulley on the crankshaft.

- 1) Install the compressor mount with hardware provided in the kit, to the three open threaded bolt points just behind the engine mount bracket.
- 2) Install the compressor onto the mount with the hardware provided. Ensure the oil fill port is oriented up.
- 3) Install the CAT 4N-7335 belt provided and tighten.





Compressor and mount in place.

CONDENSER:

The condenser mounts across the top half of the radiator fan screen above the fan hub.

1. Rotate the entire fan screen so the two halves join together horizontally instead of vertically, if required.
2. Slide the condenser and frame in across the face of the radiator fan screen above the fan hub arrangement
3. The coil is mounted to the screen by using the 'spin-lock' fastener arrangement of the 3/8" bars with the locking bolts.
4. Inset the bars through the fan screen and turn 90o to the shroud screening. Tighten the bars in place and lock with the second bolt and the large flatwasher to prevent any possibility of the locking bars loosening off.
5. Once the bars are locked in place, they don't have to be removed again. The condenser can be removed separately, making servicing of the radiator or belts quicker and easier.



Condenser as viewed from left side.

SLIP THE SPINLOCK
BETWEEN THE FAN
SCREEN BARS

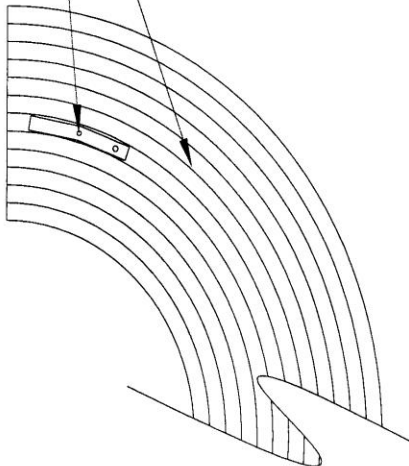

AND ROTATE 90 DEG.
AND TIGHTEN DOWN
CONDENSER
FENDER WASHERS

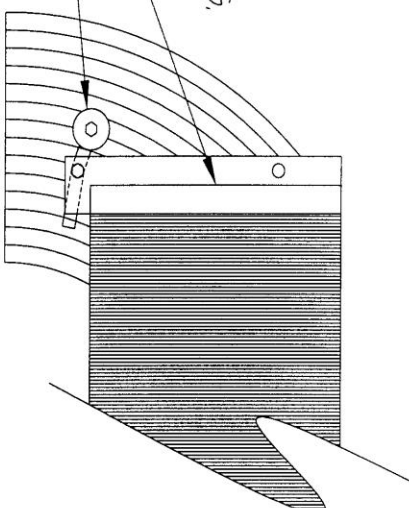

DRAWING TITLE:	
SPINLOCK INFO.	
DRAWN BY:	J.S.
APPROVED BY:	J.L.
MODIFIED ON:	MAR. 15, 2002
REV.:	0
UNITS:	S.A.E.



Condenser as viewed from right side.

RECEIVER DRIER:

The receiver drier is mounted behind the cab in the storage compartment area near the hydraulic tank fill line.

1. Bolt the straight drier bracket to the open bolt hole with the hardware provided.
2. Secure the drier to the bracket with the two #48 gear clamps in the kit. Ensure the 'INLET' fitting is pointed toward the back of the machine.



Drier in place with hoses.

HOSES:

The hoses for the air conditioning are all pre-crimped on both ends and require no crimping by the installer.

1. The 13/32" (#8) hose runs from the compressor discharge rotolock fitting under the compressor mount (see compressor mounting picture) and up the side of the fan screen. The charging port and the access for the pressure switch are on the fittings and rotolocks.
2. The first 5/16" (#6) hose runs from the condenser to the drier. From the lower fitting on the condenser the hose runs back with the 13/32" hose forward along the side of the engine into the compartment behind the cab. The 5/16" hose from the condenser attaches to the 'INLET' fitting on the drier which is oriented toward the back of the cab.
3. The shorter 5/16" (#6) hose runs from the drier to the bulkhead fitting on the back of the cab.
4. The 1/2" (#10) hose runs from the compressor suction rotolock fitting up toward the cab with the 5/16" hose from the condenser. The suction hose will then hook up to the outlet bulkhead fitting at the back of the cab. (see picture of drier mounting for orientation)



Hoses at compressor and bottom of radiator shroud.





ELECTRICAL:

The electrical arrangement on the 950 E/F is set up to be as simple to install and diagnose as possible.

1. Install the thermostat in the factory location for it on the console to the left of the operator.
2. Take power from the mode selector switch post that is live when the switch is in the A/C position (fully up) and the blower is on.
3. Connect to one terminal on the thermostat.
4. Route the clutch wire (14ga black) from the thermostat and the thermostat probe through the back of the switch box into the area adjacent to the blowers (you may find it easier if the cover behind the switches is removed) and then into the heater/evaporator box through the hole in the side.
5. Insert the thermostat probe into the coil between the 1st and 2nd rows (closest to heater) and down 5" into the coil from the top, two inches from the fitting end.
6. Route the clutch wire out the back of the cab and then back to the compressor with the suction hose.
7. Connect the switch in series and then hook up to the compressor.

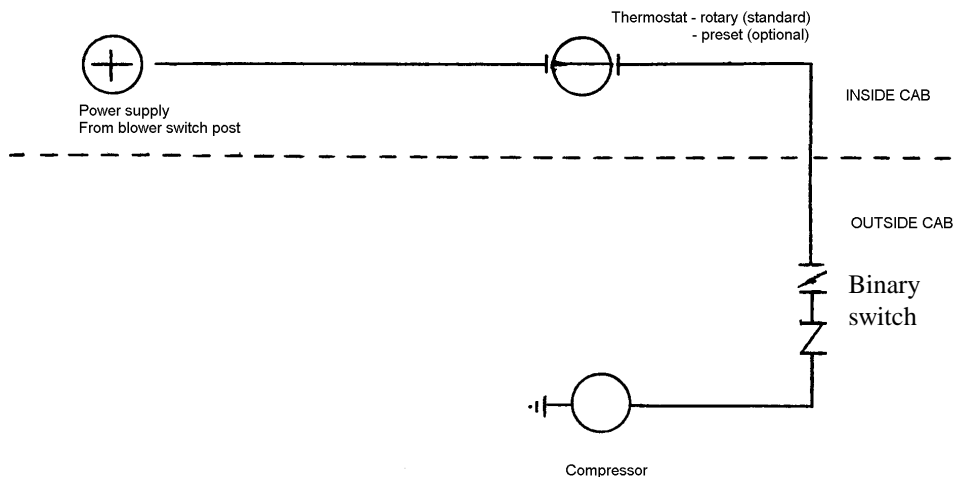



Thermostat in position.

Refrigerant Flow Pattern in a Standard Air Conditioning System

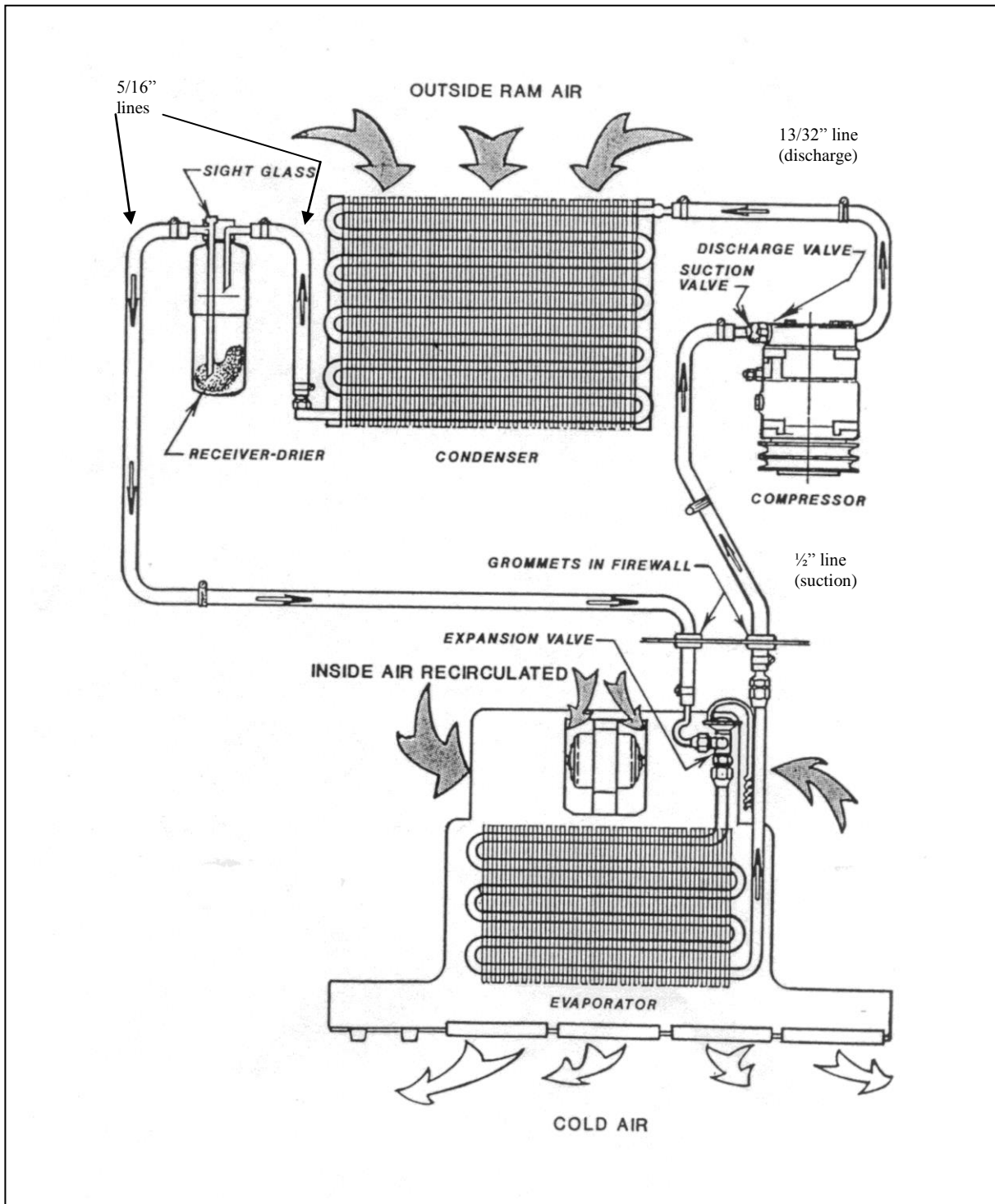

Thermostat Setting Procedures

- 1) Thermostat types
 - a) preset
 - b) adjustable
 - a) A preset thermostat is adjusted to its specific cut in and cut out temperatures when manufactured and does not have a rotary adjustment for the operator.
 - b) An adjustable or rotary thermostat has been manufactured to a predetermined cut in and cut out temperatures, but it is also operator adjustable to achieve the desired comfort level.

Both types of thermostats can have their factory settings adjusted by turning the setting screws on the body of the thermostat. One body type has the setting screws mounted externally and labeled for direction of rotation. The other body type requires the removal of the plastic end plate to expose the set screw.

- 2) Thermostat probe location: The location of the thermostat probe in an evaporator coil can be very important to achieve the maximum cooling potential of the coil while also preventing coil freeze-up. There is no set location for the thermostat probe to be put that will be optimum for all systems, but several rules of thumb may be followed:
 - a) Insert the probe in the coldest area of the evaporator coil.
 - b) Insert the probe from the top of the coil down, if possible.
 - c) Make sure that at least the last 3" of the thermostat probe are in the coil.

To find the most likely area where the coil is the coldest, consider these factors:

- 1) Direction of air flow through the coil.
 - 2) The coil area likely to have the lowest air flow.
 - 3) The inlet locations of the refrigerant into the coil.
 - 4) The inlet of the hotter outside air into the coil area.
-
- 1) Usually the coldest side of the evaporator coil will be the air outlet side. Often the thermostat probe can be inserted between the last and second last row of tubes.
 - 2) The lower air flow area of the evaporator coil in most systems tends to be near either end of the coil. These areas will be colder
 - 3) The area of the coil that the refrigerant inlet tube(s) occupy should be the coldest part of the coil.
 - 4) If the system is equipped with an outside air intake, where and how that air is brought into the evaporator area can have a large effect on the coil temperature. If all the outside air is piped into the evaporator in one area, that area will be considerably warmer in hot weather.

By looking at all these different factors, the area of an evaporator coil most likely to be the coldest can be determined.

Once the probe is inserted, the A/C system needs to be tested. Run the system to ensure that the thermostat is cycling the compressor off at the appropriate temperature. A core temperature ranging between 25° and 30° F should cause the thermostat to cycle off. The air temperature at the vent outlet closest to the evaporator coil should be between 38° F and 45° F when the compressor cycles off.

If the thermostat doesn't cycle off after a reasonable cool down period, and the air outlet temperature has dropped below 40° F, the cut in and cut out settings should be adjusted until the compressor is cycling on and off regularly. Let the system run for a decent time period (at least 15 min) and then check the evaporator coil for any signs of freezing.

Aeroquip E-Z Clip Assembly Instructions

Step 1. Cut the hose to proper length with an appropriate cutting tool. Aeroquip's hand held hose cutter has been specially designed for cutting all non-wire reinforced hose, such as GH-134 Multi-Refrigerant hose. Be sure the cut is made square to the hose length.

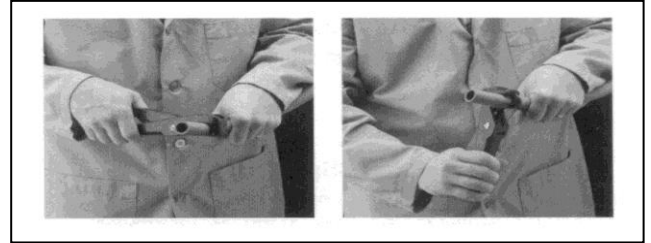

Step 2. Install two proper-sized clips onto the cut end of the hose. Orientation of the clips does not affect the performance of the connection. However, for ease of assembly, both clips should have the same orientation. NOTE: Failure to slide the clips over the hose at this time will require the clips to be stretched over the hose or fitting later. This may permanently damage the clip.

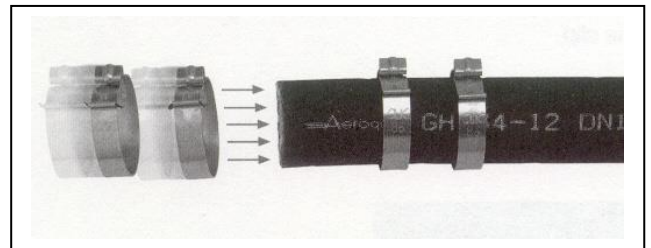

Step 3. Lubricate the nipple with a generous amount of the refrigeration or A/C system's compressor lubricating oil. This MUST be done to lower the force of nipple insertion.

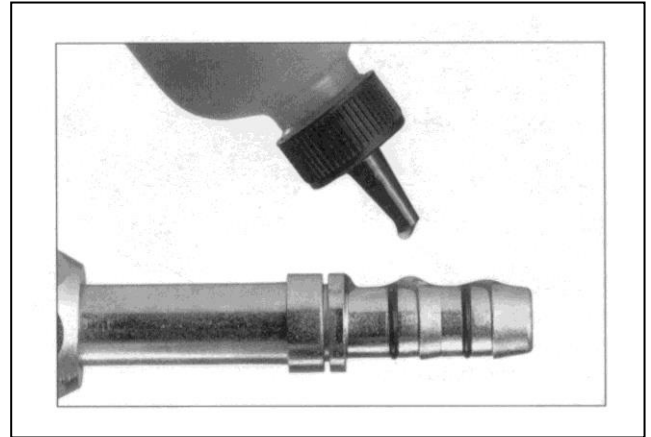

Step 4. Insert the nipple into the hose. To ensure that the nipple is fully inserted, check the gap between the cut end of the hose and the shoulder on the nipple. Care should be taken to avoid kinking or other damage to the hose during nipple insertion. NOTE: Be sure to wipe excess oil from the nipple and hose.



Step 5. Snap the cage into the groove on the nipple. The arms should extend over the hose length. When the cage has been correctly installed in the cage groove, the cage will be able to rotate in the groove. This step **MUST** be performed to ensure:

1. The clips will be located over the O-rings on the nipple.
2. The connection will be compatible with the connection's pressure rating.

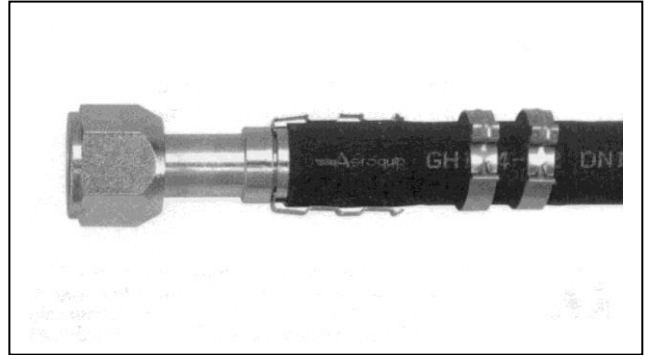

Step 6. Slide the clips over the cage arms and into the channels on each arm.



Step 7. Use the pliers to close the clips. The pliers should be positioned squarely on the clip connection points and should remain square during the closing of the clip.

NOTICE: E-Z Clip components should not be reused.

